



# Eaton 93PM UPS



*Powering Business Worldwide*

# Eaton 93PM UPS

The performance of Eaton 93PM UPS is proven with installations totaling no less than 500 MVA installed capacity globally. It provides the highest availability for mission critical applications at the lowest Total Cost of Ownership.

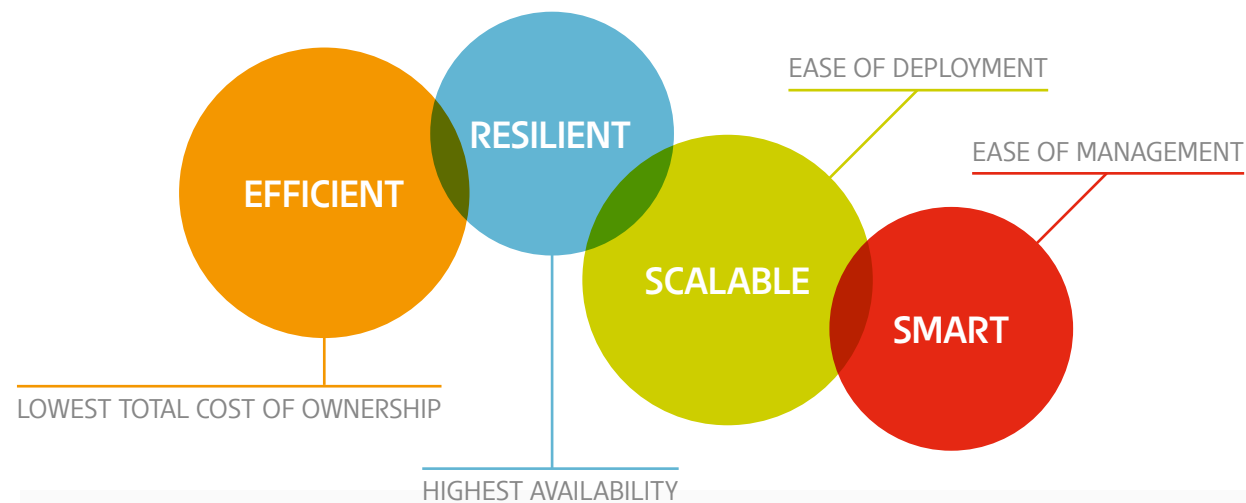

POWER RATING  
**30-500** kVA  
Can be paralleled up to 2 MVA



# 50 YEARS OF EXPERTISE



## Over 50 years of UPS Leadership

Eaton's long history of UPS expertise encompasses small, medium and large data centers as well as industrial applications. We have a deep understanding of our customers' needs, ensuring more efficient and more reliable power supply solutions.

Innovation is integral to our heritage, with patented systems such as Best Power, Powerware, MGE Office Protection Systems and B-Line.

The 93PM UPS represents the latest in our long line of market-leading, technologically advanced UPSs for mission-critical applications.

**MADE IN FINLAND**

## Made in Finland

Eaton manufacturing facility and center of competence for 3-phase UPS is located in Finland. Opened over 50 years ago, the factory has delivered more than 250 000 UPS units to date. The site hosts more than 500 visitors annually for Factory Acceptance Tests and UPS demonstrations.

## Your mission critical UPS

Whatever your mission-critical application, the 93PM UPS offers the power performance, scalability, resiliency and efficiency you need.

It is ideal for:

- Small, medium and large data centers
- Finance and banking critical infrastructure
- Commercial buildings and industrial complexes
- Transportation infrastructure
- Healthcare
- Telecommunications installations
- Process control equipment





# Eaton 93PM suits every need

Eaton 93PM is easy to deploy in various applications from Data Centers to infrastructure and rail to healthcare equipment and process automation.



UPS capacity range	30 – 60 kVA
Number of power modules	1
Maximum system size	8 UPS in parallel
Internal batteries	11 to 30 min full load runtime



UPS capacity range	30 – 250 kVA
Number of power modules	1 ... 4
Maximum system size	8 UPS in parallel



UPS capacity range	100 – 500 kVA
Number of power modules	2 ... 8
Maximum system size	4 UPS in parallel







### All-round value

Our goal is to deliver the highest availability for mission critical applications at the Lowest Total Cost of Ownership for cost-efficient business continuity.



#### Efficiency

With market leading efficiency being translated into reduced electrical and cooling losses, the 93PM helps to minimize operational expenditure. Reduced power losses also lead to higher sustainability, through reduced carbon emissions.

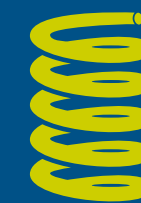

#### Resiliency

The ability of a system to absorb faults and still remain in its desired operational state is paramount to minimizing costly downtime. The 93PM includes a number of features to ensure the highest possible resiliency for mission critical applications.



#### Safety

Eaton 93PM makes electrical installation safety easy for the end users, planners and contractors – required safety equipment come integrated and inbuilt. Did you know that each UPS installation is required to be equipped with a backfeed isolation contactor and short circuit protective devices? With Eaton UPS, we have pre-designed, pre-tested and pre-installed these equipment within the UPS.



#### Scalability

Scalability helps to optimize capital expenditure by enabling the pay-as-you-grow approach. The UPS capacity can be increased at any time, simply by adding power modules to the existing UPS or by adding a new UPS in parallel to the existing installation.



# Lowest Total Cost of Ownership

The Eaton 93PM costs you less to own because it is more efficient, thanks to a number of leading technologies – some of them unique to Eaton.

## Leading Efficiency Technologies

### Lower energy consumption

Losses and energy consumption are reduced due to the market leading double conversion efficiency of up to 97% provided by the 93PM. The 93PM completely isolates output power from all input power anomalies, and delivers 100% conditioned, perfect sine-wave output even during severe power disturbance.

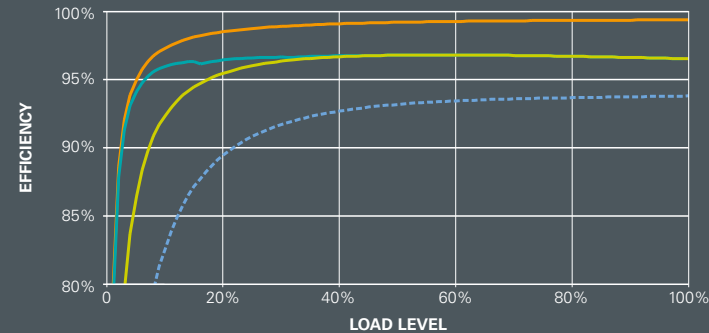

### Ultimate savings

Energy Saver System (ESS) improves the 93PM efficiency levels to 99%, by suspending the power modules when power conditioning is not required. The power is fed through the static bypass line, with double conversion operation available in less than 2ms, in the event of exceeding pre-set input limits. In addition to extremely low losses, the ESS mode provides filtering against fast low-energy transients. It is simply the most advanced, most reliable, fastest-reacting energy saver architecture available.

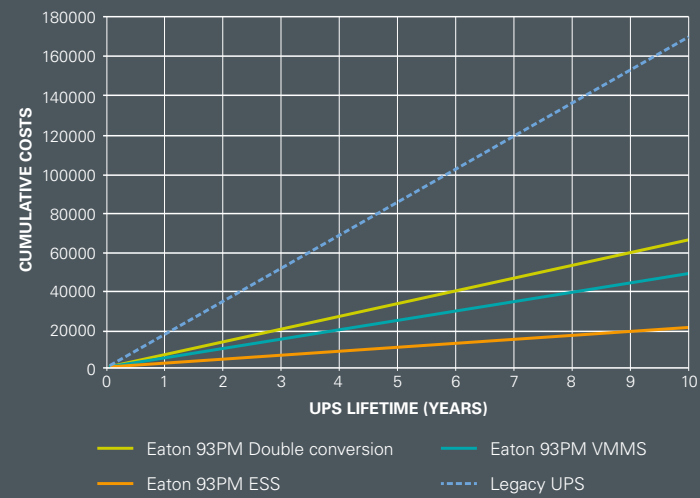

### Optimised double conversion

Variable Module Management System (VMMS) helps to achieve high efficiency even when UPS load levels are low – typical for redundant UPS systems. VMMS can optimize the load levels of power modules in a single UPS or in parallel UPS systems, by suspending extra UPS capacity. The result is optimal online efficiency at all load levels. The technology is resilient against sudden changes in load level or in available UPS capacity thanks to the Hot Sync technology.

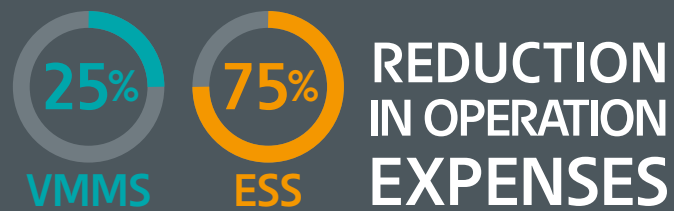

### Easy Capacity Test

Load testing can be costly and time consuming – but not with the 93PM. Its Easy Capacity Test (ECT) feature recirculates the energy from the UPS for testing. Hence there's no need to rent costly load banks and no time or energy wasted on temporary load connections.

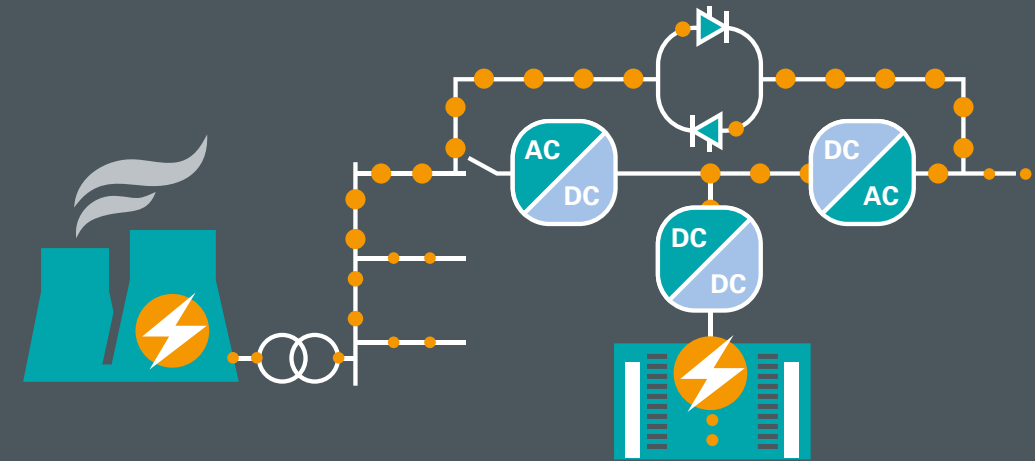

## ECT TESTING OF



**SAVING OF 1 UPS PURCHASE PRICE**

### Double conversion efficiency

High online efficiency significantly lowers operation costs and provides savings in cooling. Replacing an older generation UPS with a 93PM will be paid back in 2-3 years.



### Energy Saver System

ESS is the most proven and reliable energy saving system in the market with many years of usage within a wide install base. Even when comparing to extremely high double conversion efficiency, ESS mode can further reduce the losses by 74% with a typical UPS load.



**CO2 EMISSION REDUCTION**



**x32**   
**FLIGHTS AROUND THE GLOBE PER PERSON**

\*System of 93PM 400kW operating at 20% load level



What's in it for me?  
Check Eaton's new TCO calculator [eaton.eu/TCO](http://eaton.eu/TCO)

# Best of both - Benefits of modularity combined with resiliency

Each power module includes all components required for double conversion operation. In addition, there is one common fully rated static bypass per UPS. This topology enables combining the benefits of modularity – flexibility, availability and scalability – with the resiliency of centralized static bypass.

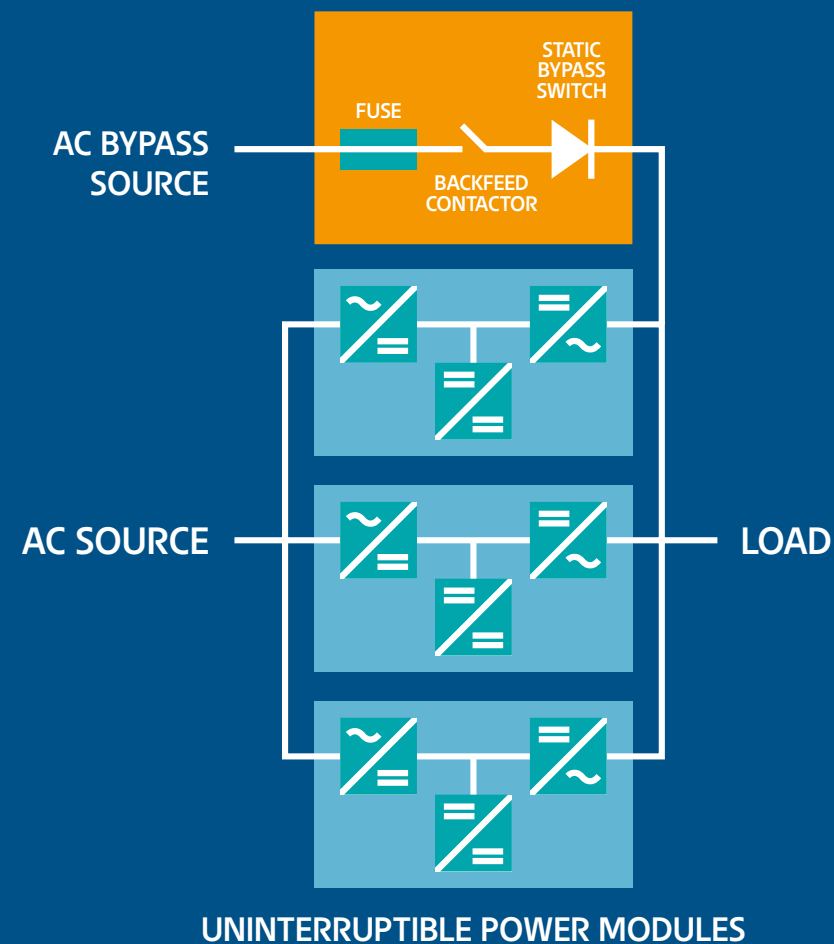
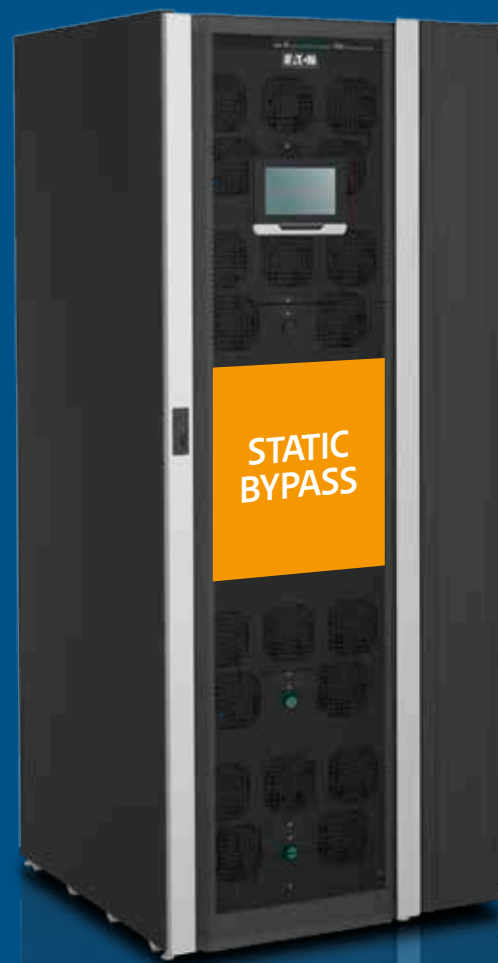

### Flexibility and availability

Modular structure can ensure the simplest possible configuration to meet site-specific UPS power and redundancy requirements flexibly.

The Uninterruptible Power Modules are able to operate independently, introducing inherent redundancy and maximizing availability of the critical load.

### Scalability

Eaton 93PM UPS provides several options for scaling and tailoring the optimal fit for your application. UPS power scaling can be achieved by adding a new UPS in parallel to the existing installation or by increasing the UPS capacity. Eaton modular UPS support scalability of capacity any time, simply by adding a new power module to the existing UPS.

### Scalable UPS design that does not compromise selectivity

The UPS bypass capacity needs to match the site requirements for selectivity from day one – even in scalable designs. Using non-compatible UPS designs, where bypass capacity changes with scalability, reduces the availability of the critical load resulting in more extensive, costly downtime. Eaton modular UPS enables designing scalable systems with full bypass capacity installed, with no compromises required for selectivity.

### Mix and match

The UPS double conversion capacity and static bypass capacity of the 93PM UPS can be sized separately, to match higher fault current levels of the installation. This enables matching of the UPS to site requirements, without the need to invest in extra UPS capacity in case of high fault current levels.

The modular design of the 93PM allows UPS capacity to be increased at any time, simply by adding power modules to the existing UPS. Capacity can be increased in steps of 50 kVA, whilst still providing full bypass capacity from day one.

SCALABILITY  
availability  
FLEXIBILITY



# Higher availability

Whatever the changing conditions – and however quickly they change – the Eaton 93PM UPS is designed to maintain a steady, uninterrupted, clean power supply. This market-leading resiliency is the result of a number of advanced technologies built-in to the 93PM.

## RELIABILITY

What makes the difference when evaluating the reliability of UPS?



**EXPERIENCE**  
of serving the applications



**PRODUCT DESIGN**  
Avoiding “conditions apply” designs



**MANUFACTURING  
PROCESS**  
Quality through processes



**PRODUCT FEATURES**  
Resiliency of the UPS system  
in various conditions

### Hot Sync

Hot Sync is a patented load-sharing technology for parallel operation of UPS inverters, without communication or load-share signals. Not relying on communication link or master-control topology, the 93PM UPS provides the highest possible reliability by eliminating the single point of failure in a parallel operating UPS system.

### Advanced Battery Management

The Advanced Battery Management extends the life of valve-regulated lead-acid (VRLA) batteries, through an intelligent charging routine. This prevents unnecessary charging and significantly retards the battery wear rate. ABM technology is widely used and accepted technology with a 20-year proven track-record.

### Reliable operation with mains supply and generator

Eaton 93PM UPS provides unity input power factor throughout the load range – providing cost savings in upstream distribution and excellent compatibility with generators. The wide frequency and voltage range of UPS rectifier ensures that batteries are not worn out even if the mains network quality is poor. Eaton 93PM UPS comes with advanced and configurable rectifier functions, such as rectifier walk-in ramp and step load reduction, On Generator-limits and delayed rectifier start-up, providing reliable operation with mains and generator.

### Electrical installation safety made easier

Designing safe electrical installations are made easy for the designers and end users of Eaton UPS. The important safety requirements are implemented into the UPS design as standard.

The installation fault current levels are determined by the size of incoming transformer. The UPS is validated for prospective short circuit current of  $I_{cc}$  100kA, which is suitable for practically all installations. Eaton 93PM UPS comes with an integrated Bussmann ultra-rapid fuse in its bypass line. Eaton UPS are guaranteed to be safe and compatible with any installation fault current levels, no conditions apply.

The UPS safety standard (IEC/EN 62040 Part 1) also requires backfeed isolation device to be connected in the UPS static bypass path due to human safety under thyristor short circuit condition. Eaton UPS come with backfeed isolation contactor integrated internally in the unit. This also guarantees that a shorted thyristor will have no effect to the double conversion operation of the UPS, removing the single point of failure.

**Eaton 93PM design ensures ease of deployment, with pre-designed, pre-tested and pre-installed safety components integrated as standard. Eliminating the need to design them into the upstream panel reduces the total cost of installation.**





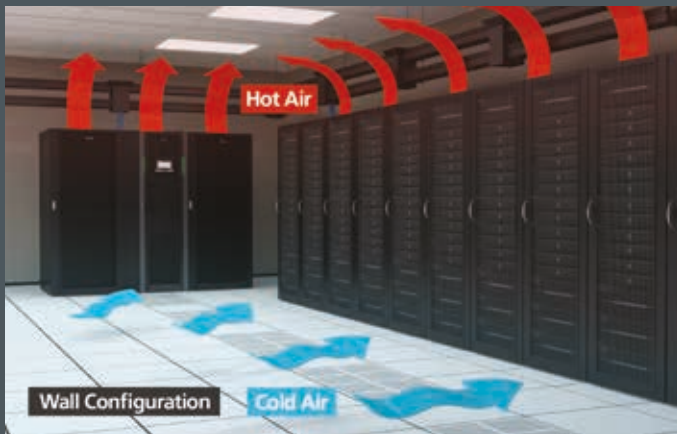

### Ease of Deployment

The fully front-accessible design allows quick access for service and maintenance. Front access, together with innovative thermal management options of front-to-top or front-to-rear airflow, also enables installation against a wall or back-to-back, in row or in hot/cold aisle configuration – maximizing deployment flexibility.

### Accessorize your UPS

Eaton's range of accessories for 3ph UPS systems provides flexible installation options that expedite deployment and save valuable space. The aesthetically designed accessories enable coordinated solutions that enhance both safety and reliability whilst reducing installation time and total cost.



### Supercapacitors

A short runtime back-up power solution has traditionally meant high-maintenance batteries or a less efficient mechanical flywheel. The new Eaton XLM Supercapacitor modules can now be integrated with the Eaton 93PM UPS to offer a new back-up power solution that is highly reliable, economical, maintenance free and manufactured from environmentally friendly materials.

The solution can tolerate high ambient temperatures and provide extremely fast recharge time. The solution can also tolerate high amount of discharge-charge cycles without significant effect to the supercapacitor health.



### UPS and Overhead Power Distribution

Employing the height and vertical space for UPS power distribution frees up floor and wall space, making it possible to easily fit 1,6 MW of UPS capacity in just six meters width. This pre-designed, pre-fabricated solution provides higher quality and fast build and expansion. The result is savings in space usage, labour and time. The solution is an optimal fit for containerized solutions and restricted spaces.

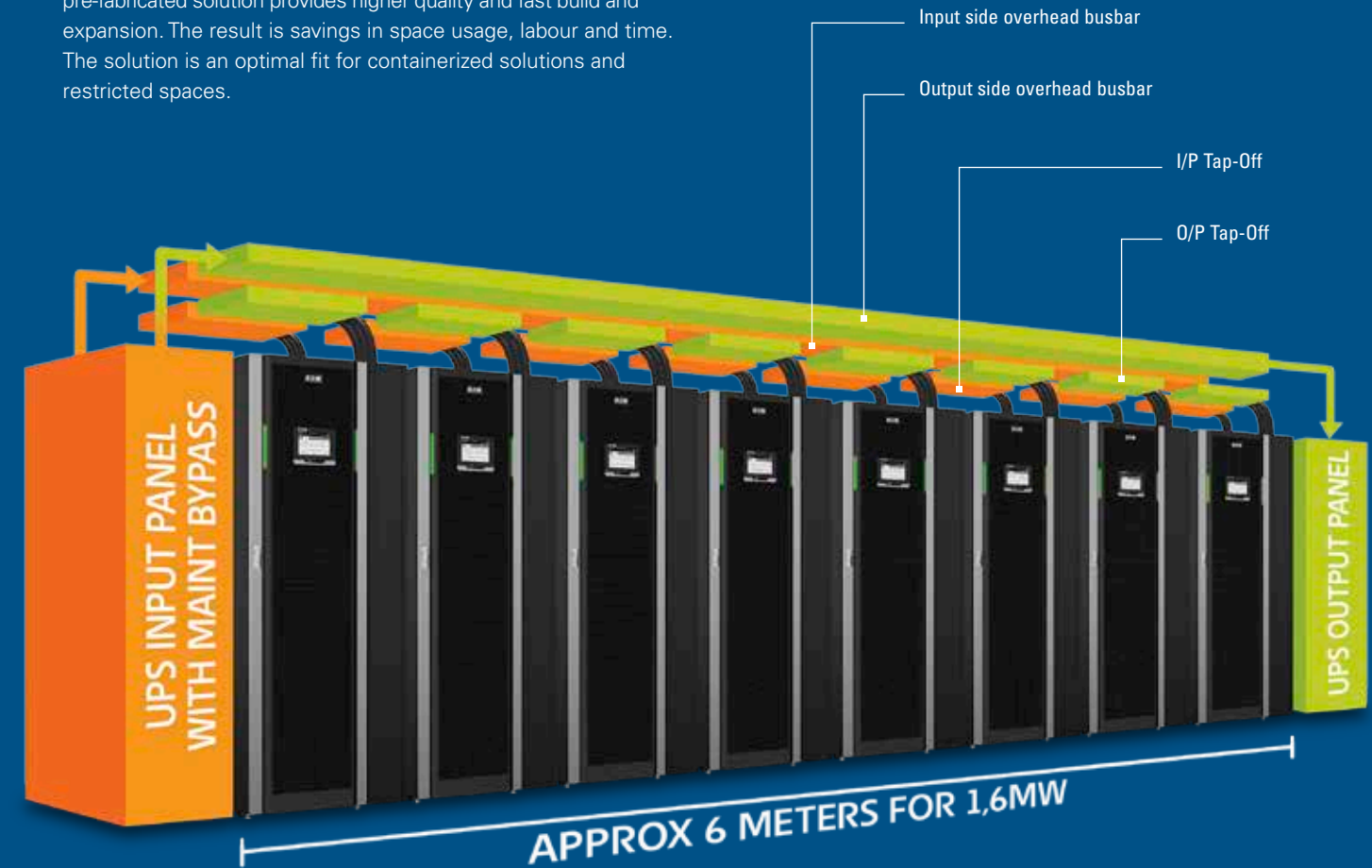

### Eaton Connected

Eaton connected is an all-in-one solution for power distribution and UPS back-up power. By bringing you pre-designed solutions and prefabricated interconnections, Eaton Connected helps you to manage installation risks by simplifying the whole process from sourcing to commissioning.

Both Eaton 93PM UPS and Eaton Power Xpert CX LV Switchgear are individually proven products in challenging applications. Now Eaton Connected is also tested and verified as one system, for your ultimate peace of mind.





## More Intelligence

**Monitoring your UPS** locally or over the cloud increases its reliability significantly and enables advanced actions **to ensure business continuity**. There could be environmental problems like too high temperature, component failures or switches in wrong position, and with a timely notification these could be corrected before they cause problems. Some actions can also be automated, like migrating virtual machines to another site if runtime is limited or availability compromised.

UPS network interfaces enable monitoring by dedicated software like Eaton's Intelligent Power Manager as well as general purpose network monitoring software, SCADA and building management systems using standard protocols like SNMP and Modbus.

While such capability is valuable, it also creates a possible target for cyberattacks. Therefore it is of utmost importance that UPS network interfaces are designed to highest security standards. Eaton's latest UPS connectivity card, **Gigabit network card, was the first UPS connectivity device to receive the UL 2900-2-2 cybersecurity certification.**



## Single pane of glass

Utilising **Eaton's Intelligent Power Software Suite** (Intelligent Power Manager IPM and Intelligent Power Protector IPP) the 93PM integrates with leading virtualization and storage platforms, and allows users to view, monitor and administer physical and virtual servers, UPSs, PDUs and other power devices, from a single pane of glass.

Network- and power-related alerts will be provided through the virtualization management application, and the 93PM will take the resiliency of the system to the next level, by bridging the electrical and IT infrastructures.

## Simple policy-based integration

**Intelligent Power Manager ensures business continuity** by enabling simple, policy-based controlled automation – driven by power and environmental events. In case of power outage, the IPM provides several options to extend runtime for critical applications:

- Load shedding: non-critical services can be suspended or carefully shut down
- Critical loads can be consolidated onto fewer host servers
- Unused host servers can be shut down
- If UPS battery levels dips below a threshold, vmotion can be triggered to move critical Virtual Machines to an unaffected host.

## Intuitive

Eaton 93PM UPS provides easier access to detailed status information through its large, **user-friendly LCD touchscreen display**. UPS status LED indicators are fitted to the UPS, providing quick and easy detection of the system status and facilitating trouble shooting







## At your service everywhere

With three Power Quality manufacturing facilities in the EMEA region, plus a strong local service presence, Eaton will provide your UPS with expert support from day one to the end of its service life.

### Peace of mind

Eaton has a service team on call 24/7, to minimize risks through early detection of problems and timely action, before disturbances or downtime result.

There are over 120 Eaton field engineers operating across EMEA – all comprehensively trained and continually updated on the latest products and technologies.

The dedicated support package they provide will ensure your equipment runs safely, reliably, sustainably and with the utmost energy efficiency, at all times.

### The proof is in the testing

The quality and reliability of the Eaton 93PM is not something you have to wait to experience, Eaton's 5 MW state-of-the-art testing facilities in Finland allow you to conduct standard and customized tests to meet your specific needs, and to address your "what if" scenarios.

## Technical specifications

General	
UPS output power rating	30-500 kVA
Efficiency in double conversion mode	Up to 97%
Variable Module Management System (VMMS) double conversion	Significantly increased efficiency at low loading
Efficiency in Energy Saver System (ESS) <sup>1</sup>	> 99%
Paralleling capability	30-200 kVA: Up to 8 units 250-500 kVA: Up to 4 units
Rectifier and inverter topology	Transformer-free 3-level IGBT-converter
Audible noise	30-60kVA: <60 dBA 80-200kVA: < 65 dBA 250-500kVA: < 69 dBA ESS mode: < 47 dBA
Altitude (max)	1000 m without derating (max 2000 m)
Input	
Input wiring	3ph + N + PE
Nominal voltage rating	220/380V; 230/400V; 240/415V 50Hz/60Hz
Input frequency range	40 to 72 Hz
Input power factor	0.99
Input iTHD	30kVA, 60kVA: < 4.5% 40-500kVA: <3%
Soft start capability	Yes
Internal backfeed protection	Yes
Output	
Output wiring	3ph + N +PE
Nominal voltage rating	220/380V; 230/400V; 240/415V 50Hz/60Hz
Load power factor range	0.8 lagging – 0.8 leading
Battery	
Battery type	VRLA
Charging mode	Advanced Battery Management or Float
Temperature compensated battery charging	Option
Battery start capability	Yes
Alternative backup power technologies	Wet cell batteries NiCd batteries Li-Ion batteries Supercapacitors
Accessories	
Long life batteries	
External battery cabinets and supercapacitor cabinets	
External maintenance bypass switch panels, Integrated manual bypass	
Battery breaker enclosures for rack batteries	
Connectivity	
Native relay inputs/outputs	5 relay inputs and dedicated EPO 1 relay output More relay contacts available as option.
Software	Eaton Intelligent Power Manager Eaton Intelligent Power Protector
Gigabit Network card (NETWORK-M2)	Web/SNMP Third party certified cybersecurity Up to 3 optional sensors (EMPDT1H1C2): Temperature, humidity and two status inputs
Industrial Gateway card (INDGW-M2)	Web/SNMP/Modbus RTU and TCP Third party certified cybersecurity Up to 3 optional sensors (EMPDT1H1C2): Temperature, humidity and two status inputs
Power Xpert UPS Minislot card (PXGMSUPS)	Web/SNMP/Modbus RTU and TCP/BACnet IP Optional Sensor (EMP001): Temperature, humidity and two status inputs
Industrial Relay-MS card (INDRELAY-MS)	5 relay outputs / 1 relay input
Compliance with standards	
Safety	IEC 62040-1; CB certified
EMC	IEC 62040-2
Performance	IEC 62040-3
RoHS	EU directive 2011/65/EU
WEEE	EU directive 2012/19/EU

<sup>1</sup> Additional information on ESS performance, refer to 93PM UPS Technical Specification.  
Due to continuous product improvement programmes, specifications are subject to change without notice.





## The future of power protection starts here

The 93PM UPS gives you a glimpse into the future of power protection.  
To see more of the future, visit [www.eaton.eu/93PM](http://www.eaton.eu/93PM) now.